

Becca Dropped Lens

SURFACE

TYPE
PROJECT

Overview

- /'beke/ BEK-e an American respelling of the Hebrew female name Rebecca, whose name means embodying the spirits of compassion and strength
- The Becca Series is a shadowless soft white diffuser that drops one inch below the finished ceiling. Because it's not molded, the corners are very sharp and create a frameless unique look, not like most molded acrylic lenses where corners are stretched
- DESIGNER SELECTION
- The Becca Series is thirty inches in both width and length and is six inches in depth. Becca series is available in both recessed and surface mount as well with a depth of five inches
- Becca Series is available in various sizes, please contact your agent so see if your requirement is available
- Becca is available in almost any CCT available in the market, we've selected the most popular, but don't let that stop you from asking for something different
- Becca Series qualifies as "Made in America" and "American Made", and it is also part of our ECO sustainable end of life program
- For all: ies files, pictures, instructions, rfa files, and warranties...scroll to bottom

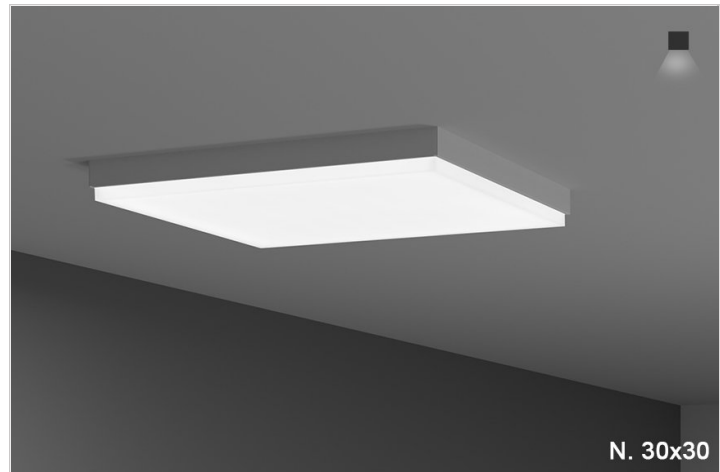

Becca Dropped Lens

SURFACE

TYPE
PROJECT

Ordering Format

PART NUMBER: BEC-SD

Size	Lumens Direct	CCT Available	CRI Available	Direct Optics
24 = 24in x 24in	D4 = 480 lms/sqft	27 = 2700 Kelvins	80 = 80-85 CRI	FW = Frosted White
30 = 30in x 30in	D6 = 640 lms/sqft	30 = 3000 Kelvins	90 = 90-95 CRI	
36 = 36in x 36in	D8 = 800 lms/sqft	35 = 3500 Kelvins		
48 = 48in x 48in	D9 = 960 lms/sqft	40 = 4000 Kelvins		
CL = Custom Length, add in notes		TW = Tunable White 2700-5000 Kelvins		
Mounting	Driver / Voltage	Fixture Finish	Options	
SM = Surface Mount CB = Cable Hung	ND = Non-Dim Universal 120-277VAC ZT = 0-10v Dimming Universal 120-277VAC 1% LE1 = Lutron EcoSystem 1% SoftOnFadeToBlack CC = Custom Control - add in notes	W = Standard White BK = Standard Black SVR = Standard Silver RAL = Enter RAL or Pantone in notes CW = Standard Wood Finish - see wood PN # enter in notes. SW = Special pattern submitted by designer	AWN = Lutron Athena Wireless Node (RF only) IK8 = IK8 Rating AWNS = Lutron Athena Wireless Node (with Sensor) Flat Panel Cable Mounted = FPB EMD = Emergency Driver - Battery Backup 120-277VAC BFL = Becca Flush Lens	

NOTES

ORDER NUMBER:

Becca Dropped Lens

SURFACE

TYPE

PROJECT

Construction & Mounting

HOUSING

Excellent design, precision-tooling and automated production is the combination that produces our troffer style housings. Most industry today uses pre-painted, folded 22 gauge steel. We use die formed 20 gauge steel with welded, grinded, sanded corners, that produces a seamless troffer with no light leaks. Our standard size is 30 x 30 Inches. We also manufacture custom sizes..

REFLECTOR

Integral powder-coated LED housing with excessive reflectivity for increased lumen output

FINISH

Standard powder-coated colors are white, black and silver. Custom processed wood finishes, aluminum anodized finishes, chrome/gold plating and custom finishes are available as well. We also accept RAL and Pantone numbers for powder-coating color choices.

OPTICS

Deep drop dish diffuser. Dish is formed soft white acrylic. Dish and reflector are a unitized assembly. Assembly is installed in housing utilizing torsion springs. Suction cup tool is provided to assist in dish removal.

MOUNTING

Surface mounted fixtures have pre-drilled holes for 1/4" threaded rod by others. Surface mounted fixtures have 1/2" knockout for power feed.

5. LIFT BRACKET / PAN INTO HOUSING. SECURE WITH SCREWS.

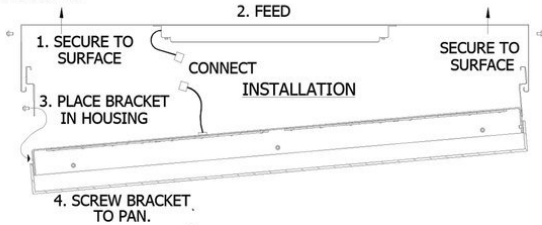

REMOVE SCREWS TO ACCESS LED PANELS AND DRIVER

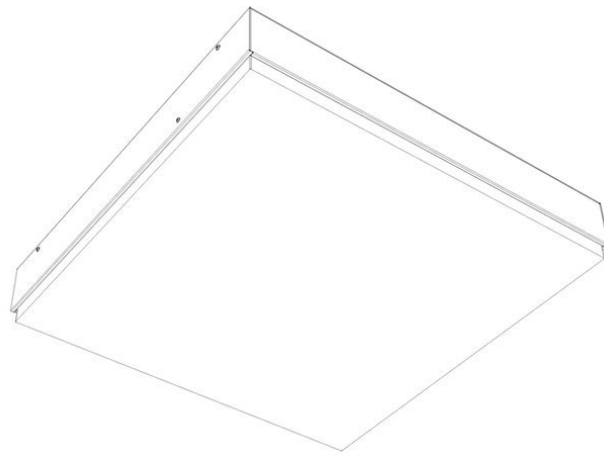
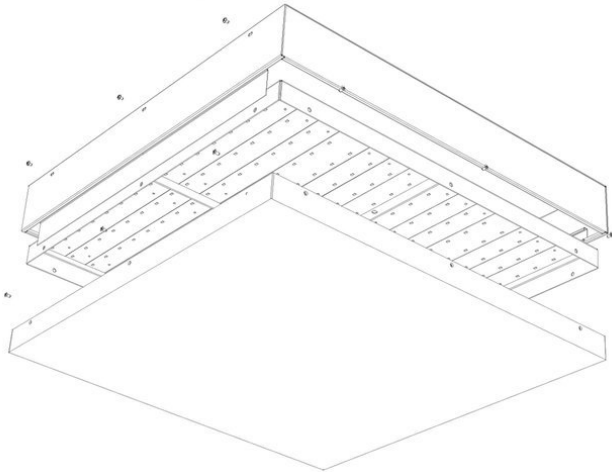
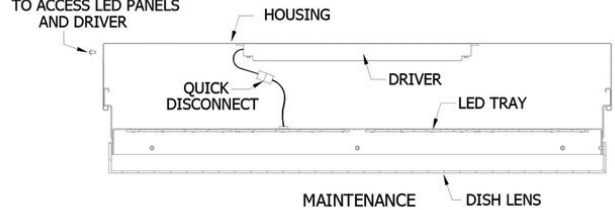

Becca Dropped Lens

SURFACE

TYPE

PROJECT

5. LIFT BRACKET / PAN INTO HOUSING. SECURE WITH SCREWS.

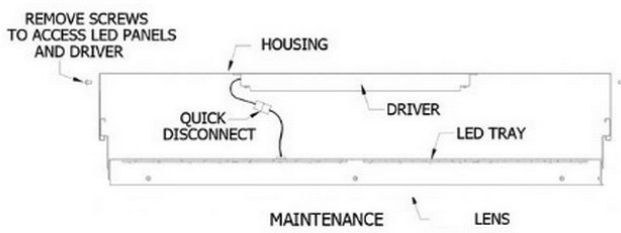
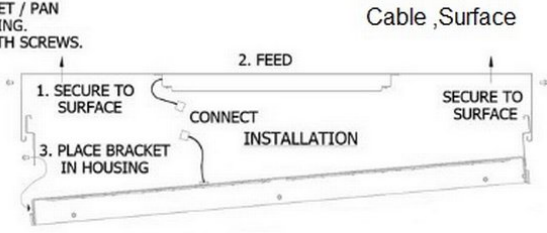

Flat Panel Becca

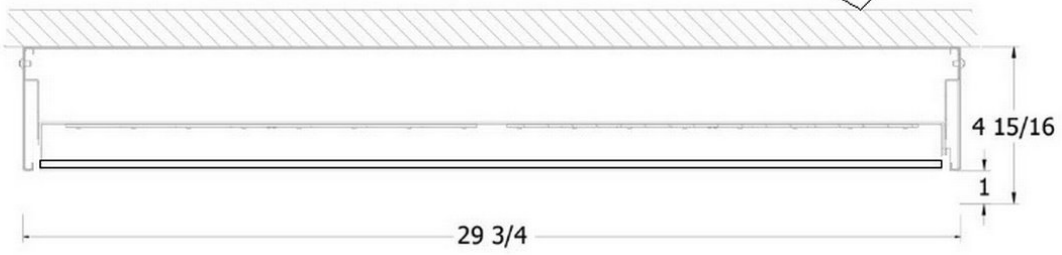
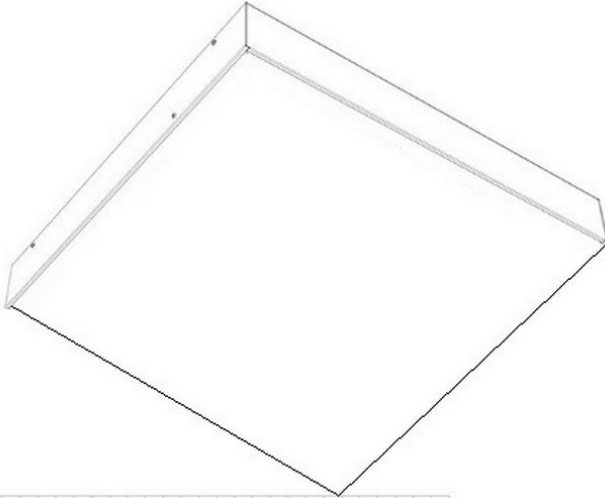
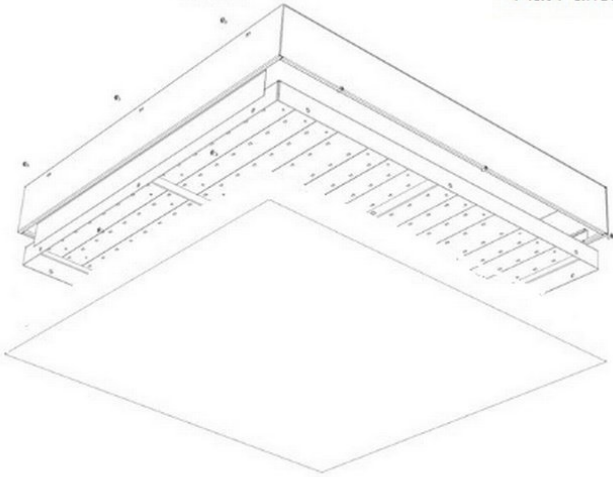

Becca Dropped Lens

SURFACE

TYPE

PROJECT

Standard Finishes



White W Black B Silver SVR

Anodized Aluminum - Premium Finishes

xxxx-B for Aluminum to be Brushed



Anodized Black AABK Anodized DK. Bronze AADB Anodized LT. Bronze AALB Anodized Champagne AALC Anodized Clear AACL

Plated Aluminum - Premium Finishes



Antique Brass PAAB Polished Chrome PAPC Polished Gold PAPG

Wood - Premium Finishes

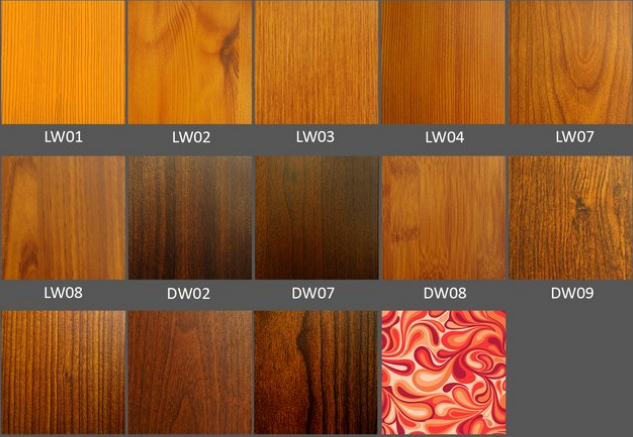

LW01 LW02 LW03 LW04 LW07
LW08 DW02 DW07 DW08 DW09
DW10 DW11 DW12 Consult Factory

Custom RAL - Custom finishes go to: tiger-coatings.com Add 8 to Notes



Standard Finishes - colors are powder coated and do not add to delivery lead time.
 Anodized Aluminum - can be smooth or brushed, color can vary fixture to fixture and adds 4-5 weeks to lead time. Anodized finish is limited in fixture size.
 Plated Aluminum - is a mirror finish in chrome and gold and adds 4-5 weeks to lead time.
 Woods Finishes - so realistic, wood finish can add up to 4-5 weeks to lead time.

Electrical / Driver

- Drivers - Our drivers are specifically selected based on fixture application to ensure ultimate reliability and long life. We use only UL recognized brands of LED drivers. Our LED drivers feature HPF (high power factor), universal voltage 110 - 277 VAC and include 0-10V dimming. Please note, 277v has longer distances from power feed to power feed than 120v.
- If required, we can supply premium drivers such as Lutron, Eldoled and others upon request. Advanced control systems compliant drivers such as POE, DALI, DMX, etc. are also available, please consult factory.
- Rated life (90% survivorship) of 50,000 hours at 50° C max. ambient (and 70° C max. case) temperature. At maximum driver load: Efficiency >84%, PF>0.9, THD
- POE - We are working with Molex/Igor POE systems. We can add a POE driver into our fixtures or remote them. Based on the fixture you select, we will notify you (or you can contact the factory) to see if we can install the P-driver or the P-driver needs to be remote. Just add POE1 in the spec and we will advise. Please keep in mind you need to specify a complete POE control system before specifying POE1.
- Our LED drivers feature HPF (high power factor), universal voltage 110 - 277 VAC and include 0-10V dimming.
- Emergency drivers are factory installed as an option, long life, high temperature, recyclable Ni-Cad battery pack with test switch and charge indicator. EMR is minimum of 90 minutes operation to meet code.
- Whip - Six feet long, wiring RHOS/Reach Compliant, 18 gauge, 600v rated, Specify wired to the fixture as an OPTION.

LED Performance

LED Output	CCT Color Temp	Watts	Lumens	Lumens per Watt	CCT Multiplier
Medium	3000	38 TW	4170 TL	109	2700=.95/3000=1 /3500=1.01/4000/1.03

- The table above is a quick reference. When calculating loads make sure you add direct and indirect LPW to get total wattage. Please refer to photometric report for detailed information.
- Our light engines are precisely designed for optimal operation of LED assemblies.
- Our standard LED's CCT (correlated color temperature) range is 2700K to 4000K. Other CCT values are available upon request.
- We log LED bin codes for each project we supply to ensure color consistency and keep a record of those projects for future reference.
- CRI offered is 80+, and 90+ Note: on 90+ CRI use .85 multiplier
- Tunable white, warm dim and other special LED colors available.
- Custom Lumens Available
- We design our own printed circuit boards to ensure high luminescence efficiency, low thermal resistance and long-term reliable operation.
- Light engines are easily replaced.
- We use only recognized brand LED's with 3 SDCM (standard deviation color matching) with high color consistency. 2 SDCM available upon request.
- If you require a special LED manufacturer, please contact us. LED chip manufacturers used by Picasso are primarily (but not limited to) Nichia, Cree and Samsung.
- LRP - "LED Reel Program" – LED's for printed circuit boards come on reels' like old 8mm projectors and they're sold in lots just like fabric. At Picasso Lighting, we have a program where we make sure all of your reels come from the same lot for each project. This ensures excellent color consistency in large open spaces.
- LED life is rated at 50,000 hours

Certifications & Warranties

Becca Dropped Lens

SURFACE

TYPE

PROJECT

- Limited five-year limited warranty on all products that are installed according to the product's specifications. Fixture must be properly installed by qualified licensed electricians, who meet and understand local installation requirements. Proper ambient conditions are to be met. The normal indoor temperatures of 50-90 degrees F, no more than 95% RH and sufficient air flow are required. Fixture should not be modified, and no maintenance or repairs should be performed without the written authorization from Picasso Lighting.
- We manufacture based on approved spec sheets and submittals signed by the customers. Change orders must be in writing and will delay delivery.
- Picasso Lighting reserves the right to repair or replace a defective product with another product with a similar design and the same or better performance, or to refund the distributor for the purchase price. The costs of labor to replace luminaires are not covered.
- Warranty does not cover damage caused by transportation, damage caused by using the fixture in an area it is not UL rated for, damage caused by negligence, lack of maintenance, attempts to repair by unqualified or unauthorized personnel, by using non-original accessories/parts, fixtures installed in systems without power surge protection.
- Picasso Lighting must receive in writing any complaints regarding the defective products, no later than 3 weeks from delivery addressed to: ttoledo@picassoltg.com. Picasso Lighting will send a field technician to the site to evaluate the said defective product or may require product to be sent back to the factory for repair. The customer is responsible for the costs of disassembly and reassembly. We do accept field repairs and replacement labor from licensed electrical contractors but not without a written agreement signed by Picasso Lighting official. Failure to adhere to all warranty and certifications will void any recompense and the warranty.
- IBEW USA Union All fixtures are IBEW manufactured and assembled in the USA. UL listed for dry and damp locations.



Note: Picasso lighting industries, LLC reserves the right to make any design changes which will not affect the overall appearance or performance of the product. All ceilings to be adequately reinforced by others. All fixtures to be wired by licensed electrician only. The information contained herein is the sole property of Picasso Lighting Industries, LLC and may not be used without prior written consent of Picasso Lighting Industries, LLC. The 'USGBC member logo' is a trademark owned by the U.S. Green building council and is used by permission. The logo signifies only that Picasso Lighting Industries, LLC is a USGBC member; USGBC does not review, certify, or endorse the products or services offered by its members.