

Blade 2 Flush Lens

PENDANT SMALL (REMOTE DRIVERS)

TYPE
PROJECT

Overview

- min-i-mal-ist noun: minimalist; plural noun: minimalists 1. a person who advocates or practices minimalism in art or music. Architecture is the art and technique of designing and building.
- Blade Series was designed for the minimalist when illuminating a space.
- DESIGNER SELECTIONS
- Blade Series has 3 profile sizes , all one and three eights inch in width and heights of two, four and six inch.
- Blade Series has 4 options for end caps with lens position: They are, dropped, regressed, flush and flush with rounded end caps.
- Blade Series has multiple choices for canopies and colors, just scroll down for your choices.
- Blade Series is available in almost any CCT available in the market, we've selected the most popular , but don't let that stop you from asking for something different.
- Blade Series is available in direct only and direct/indirect. Please note our Blade 2 is only available with remote drivers because of its small profile. We can also tune in our drivers to specific lumen output if required.
- Blade Series is always available for your projects special customization needs, just contact your local agent.
- Blade Series qualifies as "Made in America" and is part of our ECO sustainable end of life program.
- For all: ies files, pictures, instructions, rfa files, and warranties...scroll to bottom.
- Please be advised that our Blade Series is available in Pendant, Recessed, Surface and Wall.

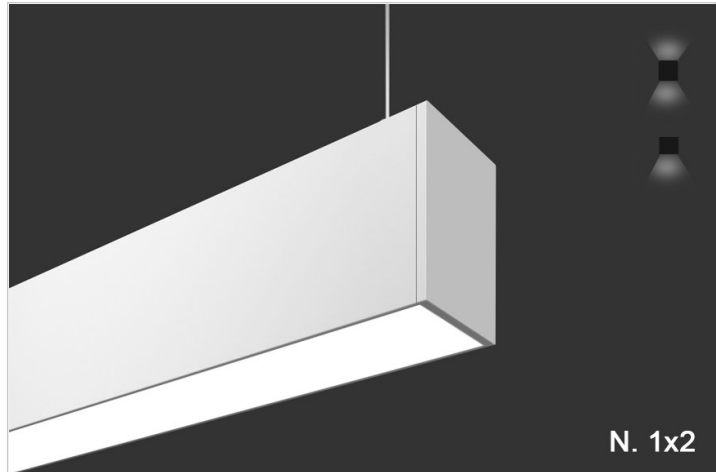

Blade 2 Flush Lens

PENDANT SMALL (REMOTE DRIVERS)

TYPE

PROJECT

Ordering Format

PART NUMBER: BLD-2-PF

Size	Lumens Direct	Lumens Indirect	CCT Available	CRI Available
2 = 2 Feet	D3 = 350 LPF	I3 = 350 LPF	27 = 2700 Kelvins	80 = 80-85 CRI
3 = 3 Feet	D5 = 500 LPF	I5 = 500 LPF	30 = 3000 Kelvins	90 = 90-95 CRI
4 = 4 Feet		NN = Not Needed	35 = 3500 Kelvins	
6 = 6 Feet			40 = 4000 Kelvins	
8 = 8 Feet			TW = Tunable White 2700-5000 Kelvins	
CL = Custom Length, add in notes				
Direct Optics	Indirect Optics	Mounting	Driver / Voltage	Fixture Finish
FWF = Frosted White Flush	ILW = Lambertian White Lens IBW120 = Batwing 120 Degree Beam IF150 = Flat 150 Degree Beam IA6040 = Asymmetric 60 Degree Beam @40 Degree Tilt IA4560 = Asymmetric 45 Degree Beam @60 Degree Tilt	LV1CR = Small Custom Rectangular Canopy / Driver Remote/Power Low Voltage LV1R = Round 5in Canopy JBox - Driver Remote/Power Low Voltage LV1S = Square 5in Canopy JBox - Driver Remote/Power Low Voltage LVRR = Driver Remote Round 5in Canopy JBox - 2in Support 1/4 Rod LVRS = Driver Remote Square 5in Canopy JBox - 2in Support 1/4 Rod LVD1R = Driver Remote Round 5in Canopy JBox - 2in Support Slot Grid LVD1S = Driver Remote Square 5in Canopy JBox - 2in Support Slot Grid LVD2R = Driver Remote Round 5in Canopy JBox - 2in Support T Grid LVD2S = Driver Remote Square 5in Canopy JBox - 2in Support T Grid LVUR = Driver Remote Round 5in Canopy JBox - .5in Support Unistrut LVUS = Driver Remote Square 5in Canopy JBox - .5in Support Unistrut RLVIDF = Recessed Housing w/ Integral Drivers /Power Low Voltage/Trim RLVIDS = Recessed Housing w/ Integral Drivers /Power Low	RND 1 = Remote Non-Dim Universal 120VAC RND 2 = Remote Non-Dim Universal 277VAC RZT 1 = Remote 0-10v dimming 120v dual 1% RZT 2 = Remote 0-10v dimming 277v dual 1% RLE1 = Remote Lutron EcoSystem 1% DLC EE CCR / PWM SoftOnFadeToBlack RCC = Remote Custom Control - add in notes	W = Standard White BK = Standard Black SVR = Standard Silver RAL = Enter RAL # in notes section PA = Plated Aluminum-enter plated finish in notes CW = Standard Wood Finish - see wood PN # enter in notes. SW = Special pattern submitted by designer AA = Anodized Aluminum -enter PN in notes section

Blade 2 Flush Lens

PENDANT SMALL (REMOTE DRIVERS)

TYPE
PROJECT

		<p>Voltage/Trimless</p> <p>SLVIDT-C = Surface Housing w/ Integral Drivers /Power Low Voltage/Top KO Power</p> <p>SLVIDS-C = Surface Housing w/ Integral Drivers /Power Low Voltage/Side KO Power</p> <p>SLVIDT = Surface Housing w/ Integral Drivers /Power Low Voltage/Top KO Power/Support and Power on Box</p> <p>SLVIDS = Surface Housing w/ Integral Drivers /Power Low Voltage/Side KO Power/Support and Power on Box</p>		
--	--	---	--	--

Canopy/Power Cord Color	Cap Finishes	Options
<p>CW-LVPW = Canopy White/ LV 18/2 Power Cord White</p> <p>CB-LVPW = Canopy Black/ LV 18/2 Power Cord White</p> <p>CB-LVPB = Canopy Black/ LV 18/2 Power Cord Black</p> <p>CW-LVPB = Canopy White/ LV 18/2 Power Cord Black</p> <p>CW-LVC = Canopy White/ LV 18 Power Cable - Individual Only 4', 8'</p> <p>CB-LVC = Canopy Black/ LV 18 Power Cable - Individual Only 4', 8'</p>	<p>SEC = Standard end cap</p> <p>REC = Rounded end cap to match the fixture color you select</p>	<p>AWN = Lutron Athena Wireless Node (RF only)</p> <p>AWNS = Lutron Athena Wireless Node (with Sensor)</p> <p>2C = 2 circuit wiring for direct indirect</p> <p>CA = Custom Angle, add in notes</p> <p>OS = Occupancy Sensor</p> <p>REMD = Remote Emergency Driver - Battery Backup 120-277VAC</p>

NOTES

ORDER NUMBER:

Blade 2 Flush Lens

PENDANT SMALL (REMOTE DRIVERS)

TYPE

PROJECT

Construction & Mounting

HOUSING

Extruded aluminum housings are supplied in nominal lengths of 2 ft- 8 ft. Fixtures may be continuously rowed (contact factory for details). Easy access to remote driver and LED boards. End caps are extruded aluminum.

REFLECTOR

Integral powder-coated LED housing with excessive reflectivity for increased lumen output

FINISH

Standard powder-coated colors are white, black and silver. Custom processed wood finishes, aluminum anodized finishes, chrome/gold plating and custom finishes are available as well. We also accept RAL and Pantone numbers for powder-coating color choices.

OPTICS

Extruded snap-in frosted acrylic lens formulated for LED light sources.

MOUNTING

Cable mounting supports and powers the blade 2 because it's too small to fit a driver. Various size canopies and different power supplies are available. Cable uses gripper style locking for field adjustments and is connected to the driver. Canopy mounts to standard J-box and the standard cable lengths are 4 feet.

LABELING

UL Approved IBEW Union Made

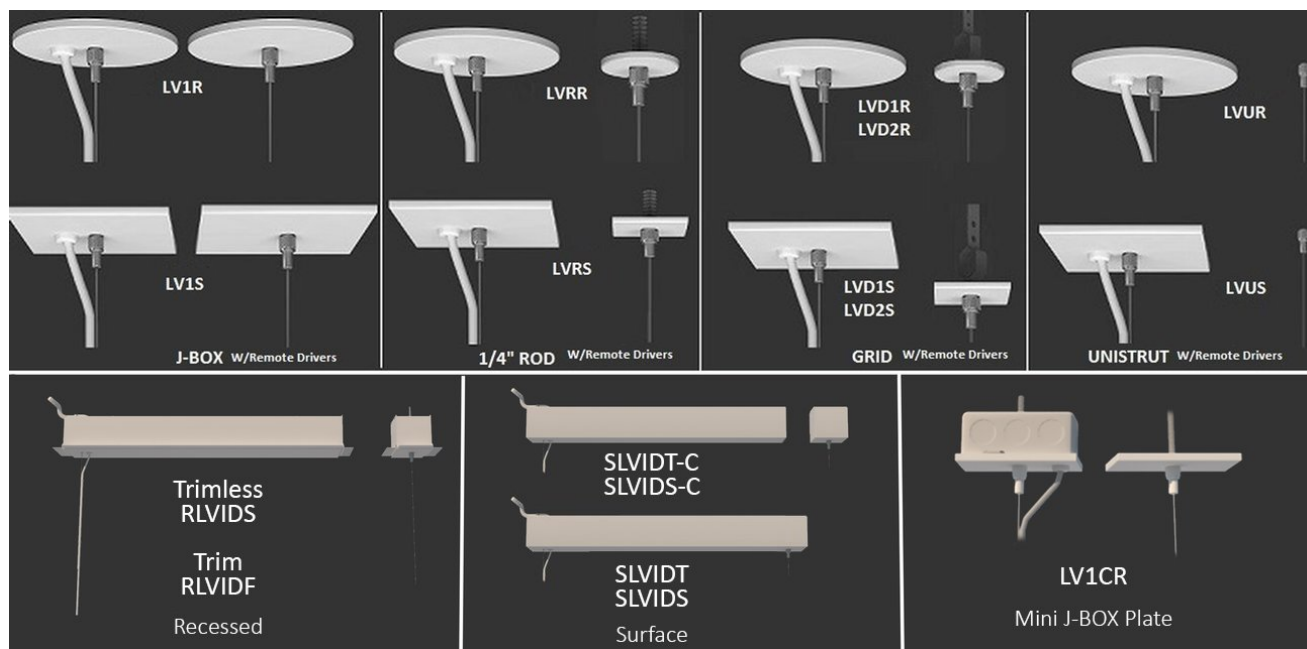

Blade 2 Flush Lens

PENDANT SMALL (REMOTE DRIVERS)

TYPE
PROJECT

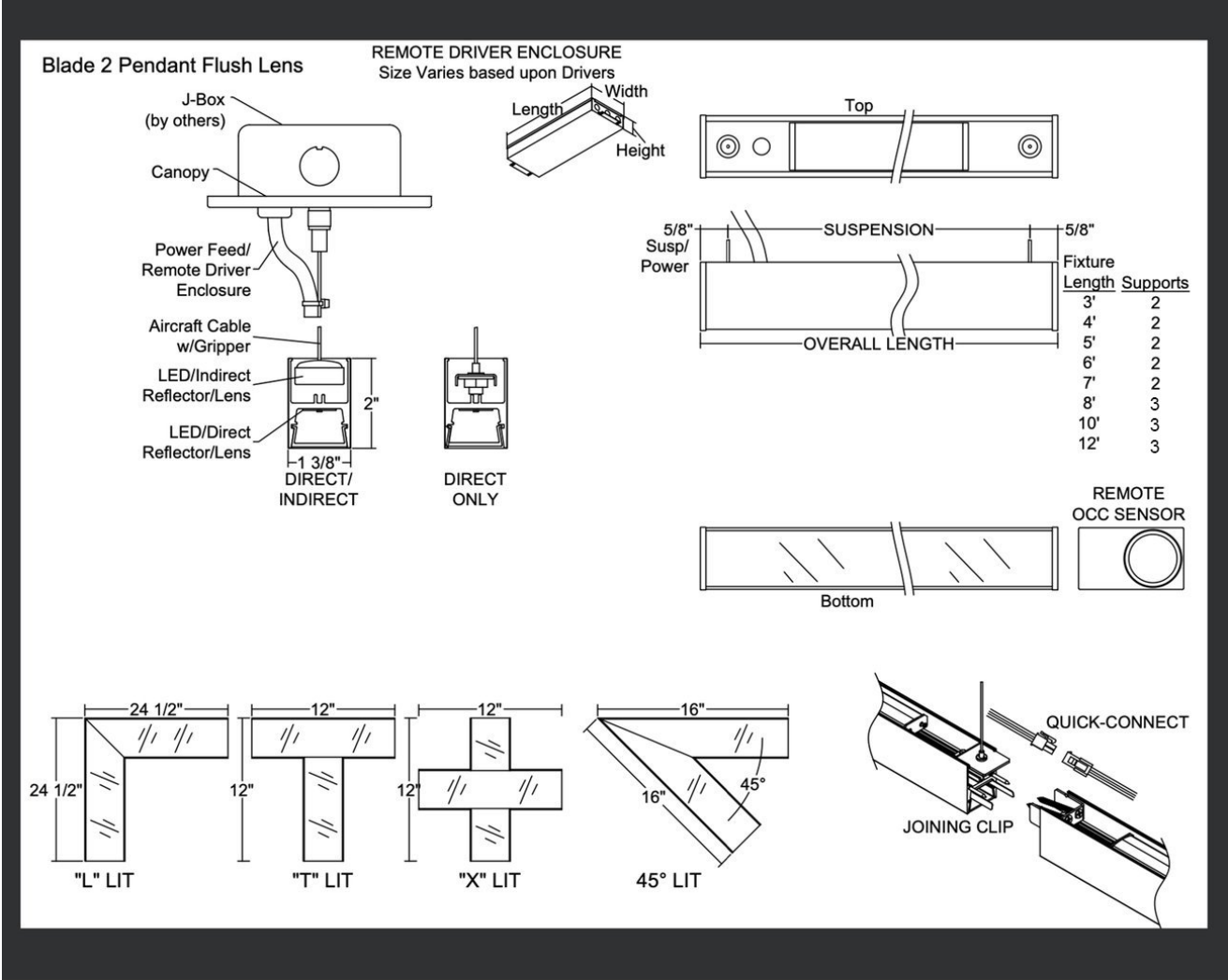

Blade 2 Flush Lens

PENDANT SMALL (REMOTE DRIVERS)

TYPE
PROJECT

Blade 2 Surface and Recessed Driver Mounting Options

SURFACE MOUNTED DRIVER

SURFACE MOUNTED DRIVER ENCLOSURE
SURFACE MOUNT 4' < LENGTH < 8' INDIVIDUAL
SLVIDT TOP POWER FEED
SLVIDS END POWER FEED
NO EMD

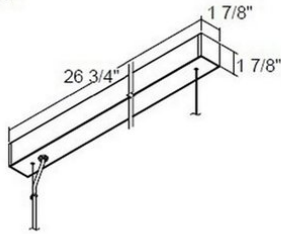

SURFACE MOUNTED DRIVER ENCLOSURE
SURFACE MOUNT RUNS or 8' > INDIVIDUAL
SLVIDT-C TOP POWER FEED
SLVIDS-C END POWER FEED
EMD

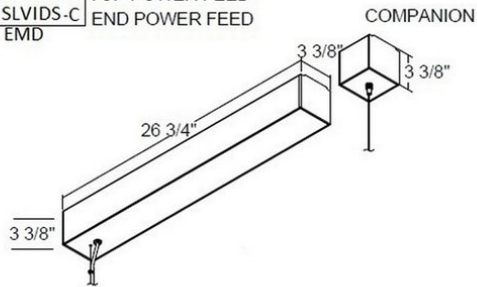

RECESSED DRIVER

SPACKLE FLANGE MOUNTED DRIVER ENCLOSURE
SPACKLE FLANGE TRIMLESS RECESSED
RLVIDS
EMD

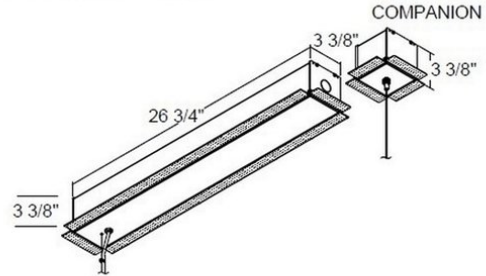

TRIM FLANGE MOUNTED DRIVER ENCLOSURE
TRIM FLANGE RECESSED
RLVIDF
EMD

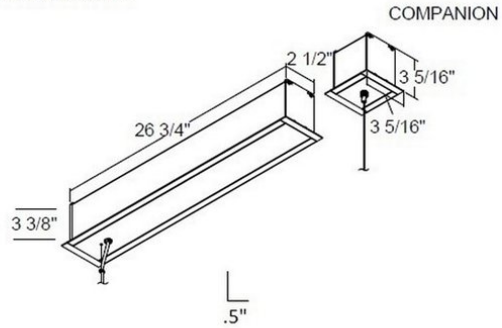

Blade 2 Flush Lens

PENDANT SMALL (REMOTE DRIVERS)

TYPE
PROJECT

Blade 2 Remote Driver Mounting Options

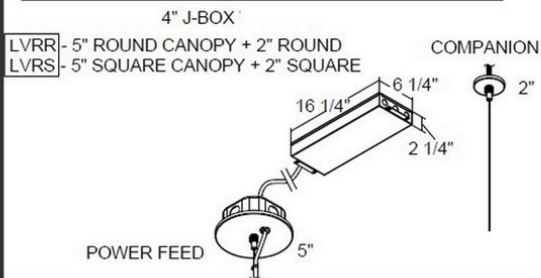
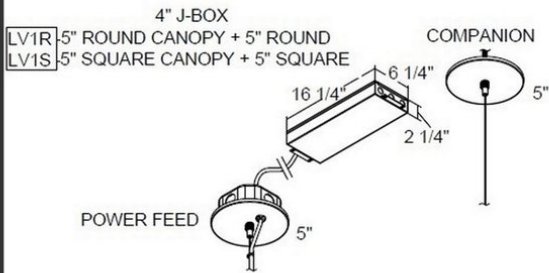
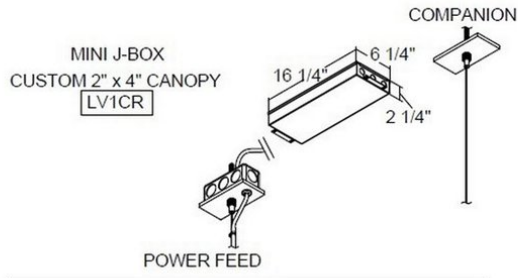

SLOT GRID INSTALLATION:

- LVD1R - 5" ROUND CANOPY + 5" ROUND
- LVD2R - 5" ROUND CANOPY + 2" ROUND
- LVD1S - 5" SQUARE CANOPY + 5" SQUARE
- LVD2S - 5" SQUARE CANOPY + 2" SQUARE

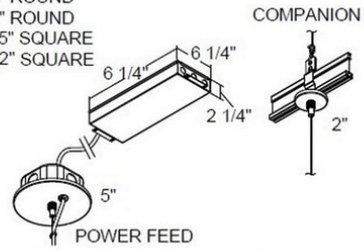

9/16" TEE GRID INSTALLATION:

- LVD1R - 5" ROUND CANOPY + 5" ROUND
- LVD2R - 5" ROUND CANOPY + 2" ROUND
- LVD1S - 5" SQUARE CANOPY + 5" SQUARE
- LVD2S - 5" SQUARE CANOPY + 2" SQUARE

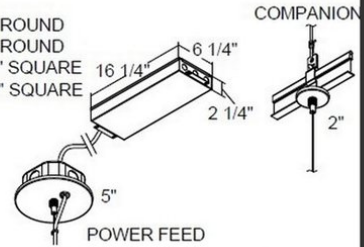

UNISTRUT INSTALLATION WITH:

- LVUR - 5" ROUND CANOPY 1/2" COUPLING
- LVUS - 5" SQUARE CANOPY 1/2" COUPLING

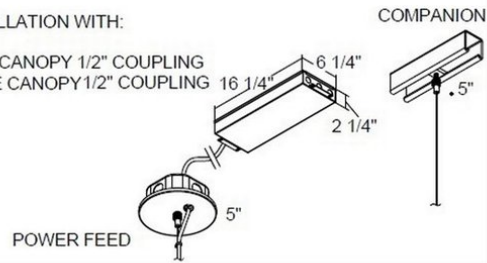

Blade 2 Flush Lens

PENDANT SMALL (REMOTE DRIVERS)

TYPE

PROJECT

Standard Finishes



White
W

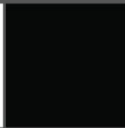

Black
B



Silver
SVR

Anodized Aluminum - Premium Finishes

xxxx-B for Aluminum to be Brushed



Anodized Black
AABK



Anodized DK.
Bronze
AADB



Anodized LT.
Bronze
AALB



Anodized
Champagne
AALC



Anodized Clear
AACL

Custom RAL - Custom finishes go to: tiger-coatings.com Add 8 to Notes



Plated Aluminum - Premium Finishes



Antique Brass
PAAB





Polished Chrome
PAPC





Polished Gold
PAPG

Wood - Premium Finishes

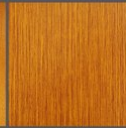

LW01



LW02



LW03



LW04



LW07



LW08



DW02

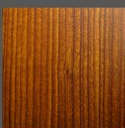

DW07

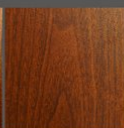

DW08

DW09

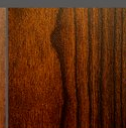
DW10

DW11

DW12

Consult Factory

Standard Finishes - colors are powder coated and do not add to delivery lead time.

Anodized Aluminum - can be smooth or brushed, color can vary fixture to fixture and adds 4-5 weeks to lead time. Anodized finish is limited in fixture size.

Plated Aluminum - is a mirror finish in chrome and gold and adds 4-5 weeks to lead time.

Woods Finishes - so realistic, wood finish can add up to 4-5 weeks to lead time.

Blade 2 Flush Lens

PENDANT SMALL (REMOTE DRIVERS)

TYPE

PROJECT

Electrical / Driver

- Drivers - Our drivers are specifically selected based on fixture application to ensure ultimate reliability and long life. We use only UL recognized brands of LED drivers. Our LED drivers feature HPF (high power factor), universal voltage 110 - 277 VAC and include 0-10V dimming. Please note, 277v has longer distances from power feed to power feed then 120v.
- If required, we can supply premium drivers such as Lutron, Eldoled and others upon request. Advanced control systems compliant drivers such as POE, DALI, DMX, etc. are also available, please consult factory.
- Rated life (90% survivorship) of 50,000 hours at 50° C max. ambient (and 70° C max. case) temperature. At maximum driver load: Efficiency >84%, PF>0.9, THD
- Our LED drivers feature HPF (high power factor), universal voltage 110 - 277 VAC and include 0-10V dimming.
- Remote emergency drivers are an option, long life, high temperature, recyclable Ni-Cad battery pack with test switch and charge indicator. EMR is a minimum of 90 minutes operation to meet code.
- POE - We are working with Molex/Igor POE systems. We can add a POE driver into our fixtures or remote them. Based on the fixture you select, we will notify you (or you can contact the factory) to see if we can install the P-driver or the P-driver needs to be remote. Just add POE1 in the spec and we will advise. Please keep in mind you need to specify a complete POE control system before specifying POE1.

LED Performance

LED Output	CCT Color Temp	Watts	Lumens	Lumens per Watt	CCT Multiplier
Low	3000	5.01 WPF (Indirect 2.7 WPF)	350 LPF	68 LPW	2700 = .95
Medium	3000	7.03 WPF (Indirect 3.9WPF)	500 LPF	66 LPW	3000=1 / 3500=1.01/4000/1.03

- We design our own printed circuit boards to ensure high luminescence efficiency, low thermal resistance and long-term reliable operation.
- Light engines are easily replaced.
- We use only recognized brand LED's with 3 SDCM (standard deviation color matching) with high color consistency. 2 SDCM available upon request.
- If you require a special LED manufacturer, please contact us. LED chip manufacturers used by Picasso are primarily (but not limited to) Nichia, Cree and Samsung.
- LRP - "LED Reel Program" – LED's for printed circuit boards come on reels' like old 8mm projectors and they're sold in lots just like fabric. At Picasso Lighting, we have a program where we make sure all of your reels come from the same lot for each project. This ensures excellent color consistency in large open spaces.
- LED life is rated at 50,000 hours
- Our light engines are precisely designed for optimal operation of LED assemblies.
- Our standard LED's CCT (correlated color temperature) range is 2700K to 4000K. Other CCT values are available upon request.
- We log LED bin codes for each project we supply to ensure color consistency and keep a record of those projects for future reference.
- CRI offered is 80+, and 90+ Note: on 90+ CRI use .85 multiplier
- Tunable white, warm dim and other special LED colors available.
- Custom Lumens Available

Certifications & Warranties

- Limited five-year limited warranty on all products that are installed according to the product's specifications. Fixture must be properly installed by qualified licensed electricians, who meet and understand local installation requirements. Proper ambient conditions are to be met. The normal indoor temperatures of 50-90 degrees F, no more than 95% RH and sufficient air flow are required. Fixture should not be modified, and no maintenance or repairs should be performed without the written authorization from Picasso Lighting.
- We manufacture based on approved spec sheets and submittals signed by the customers. Change orders must be in writing and will delay delivery.
- Picasso Lighting reserves the right to repair or replace a defective product with another product with a similar design and the same or better performance, or to refund the distributor for the purchase price. The costs of labor to replace luminaires are not covered.
- Warranty does not cover damage caused by transportation, damage caused by using the fixture in an area it is not UL rated for, damage caused by negligence, lack of maintenance, attempts to repair by unqualified or unauthorized personnel, by using non-original accessories/parts, fixtures installed in systems without power surge protection.
- Picasso Lighting must receive in writing any complaints regarding the defective products, no later than 3 weeks from delivery addressed to: ttoledo@picassoltg.com. Picasso Lighting will send a field technician to the site to evaluate the said defective product or may require product to be sent back to the factory for repair. The customer is responsible for the costs of disassembly and reassembly. We do accept field repairs and replacement labor from licensed electrical contractors but not without a written agreement signed by Picasso Lighting official. Failure to adhere to all warranty and certifications will void any recompense and the warranty.
- IBEW USA Union All fixtures are IBEW manufactured

Blade 2 Flush Lens

PENDANT SMALL (REMOTE DRIVERS)

TYPE
PROJECT

and assembled in the USA. UL listed for dry and damp locations.



Note: Picasso lighting industries, LLC reserves the right to make any design changes which will not affect the overall appearance or performance of the product. All ceilings to be adequately reinforced by others. All fixtures to be wired by licensed electrician only. The information contained herein is the sole property of Picasso Lighting Industries, LLC and may not be used without prior written consent of Picasso Lighting Industries, LLC. The 'USGBC member logo' is a trademark owned by the U.S. Green building council and is used by permission. The logo signifies only that Picasso Lighting Industries, LLC is a USGBC member; USGBC does not review, certify, or endorse the products or services offered by its members.